



NAVAL
POSTGRADUATE
SCHOOL

Perhaps Bigger *is* Better: Density as a Naval Submarine Cost Driver

LT Benjamin Grant, USN
BS Mechanical Engineering, Cal Poly, San Luis Obispo
NPS Acquisition Symposium
15 May 2008

The Nation's Premiere Defense Research University

Monterey, California
WWW.NPS.EDU





- Size and weight management are cost-saving measures that are *costing us*.
- Arc-Permeability Factor (APF) is an excellent measure of density.
- Density trends may represent a previously unexplained driver of historic submarine cost growth in excess of inflation.



A cost saving measure that is costing us

1. Mass dispersion analysis shows weight-optimized designs do not minimize cost.
2. Efforts to minimize weight have driven us toward designs with suboptimal hydrodynamic characteristics.
3. Tendency to underestimate the effects of construction methods have on the relationship between deck surface area and weight .
4. Diminishing benefits of Moore's Law.
5. 14 of 18 ship classes retired due to obsolescence prior to design end of life.
6. Unnecessary tolerances, engineered materials and unique parts.
7. Acquisition environment (Low-rate production environment and shallow industrial base) is a relevant cost consideration and *independent* of weight.
8. Ticonderoga Class cruiser cost per ton vs. Spruance Class destroyer.
9. LA Class transition from volume to weight limited.
10. "Weight is great for [steel] plate." – Dave Bergheimer, EB Cost Engineer.

Significant evidence exists against the treatment of weight as a cost driver.



A cost saving measure that is costing us

Deck Surface Area:

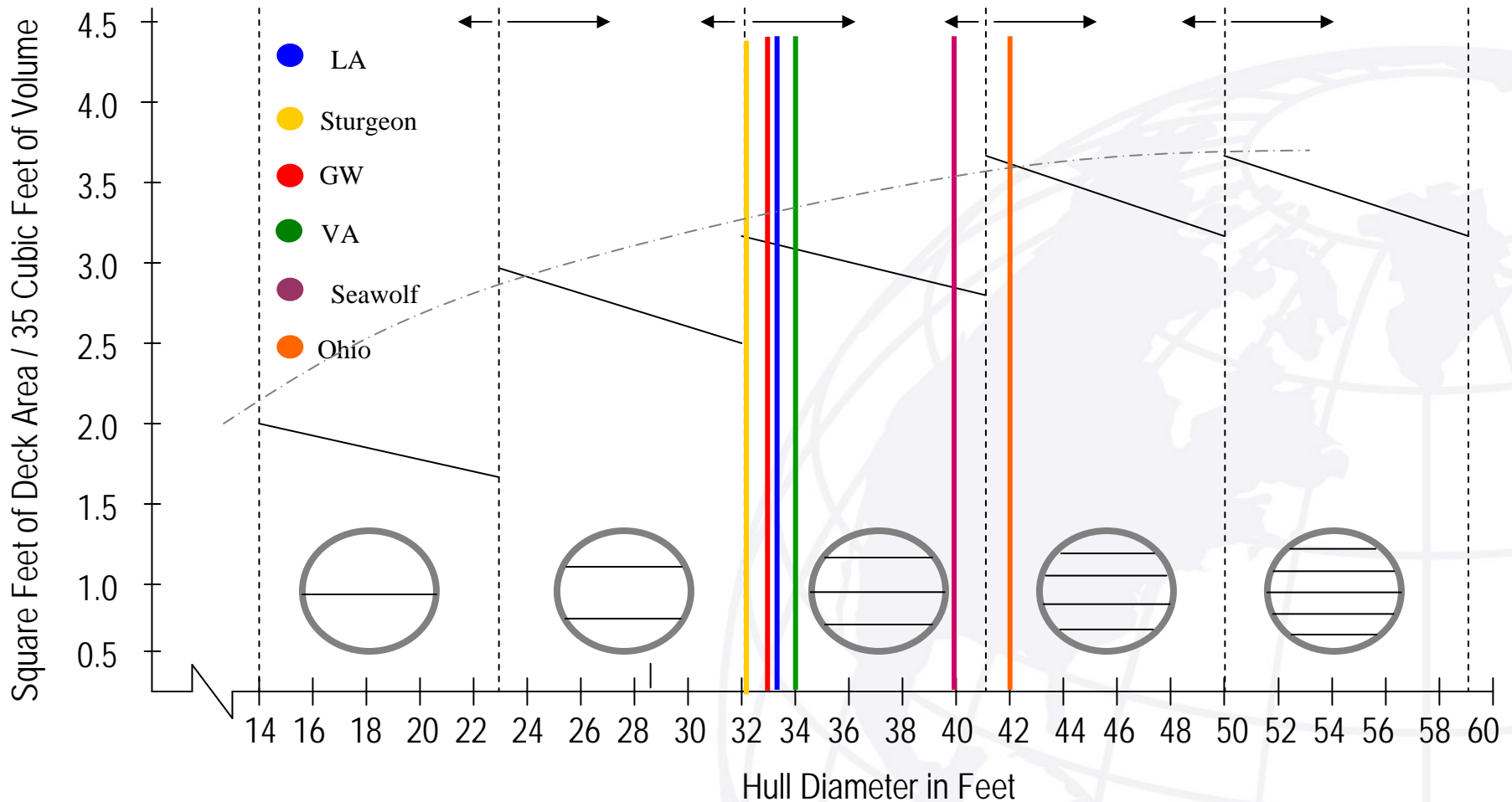

Marginal gain in deck surface area drops off > 4 decks.

Max surface area for given # of decks varies w/ construction method.



A cost saving measure that is costing us

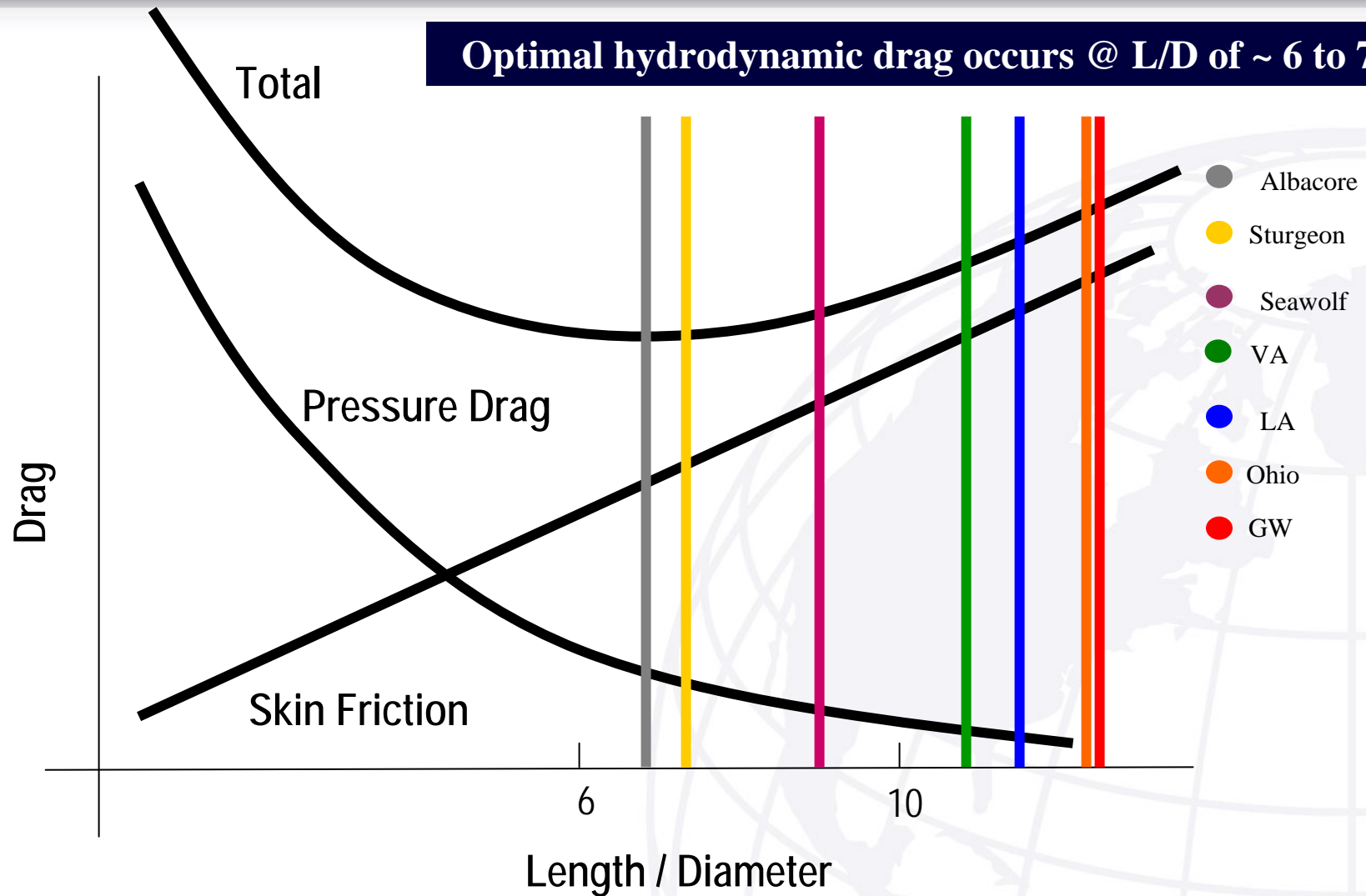

An increase in hull diameter could have a neutral or even beneficial effect on hydrodynamic drag along w/ an increase in useable volume.



A cost saving measure that is costing us

Mass Dispersion:

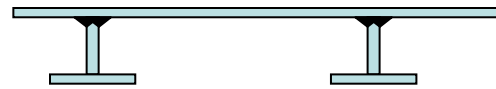

Newport News Deck Design



Electric Boat Deck Design

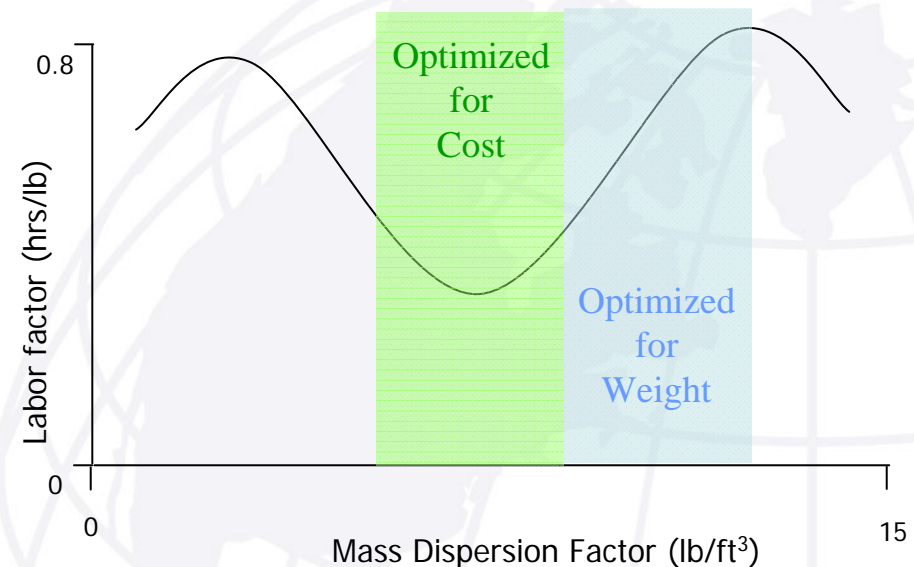
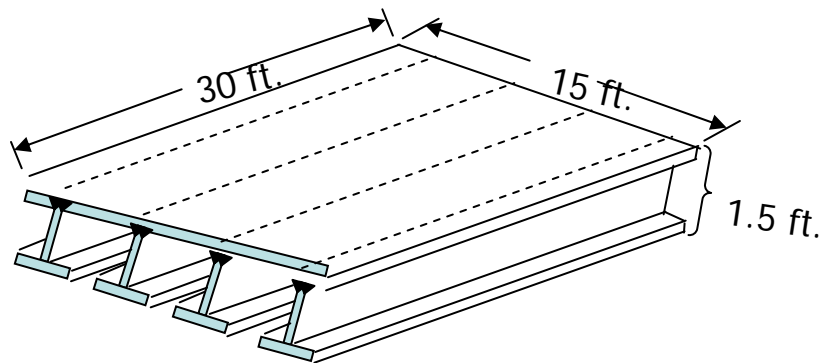

Example Problem

Deck Weight = plate weight + tee weight + chocks + foundation back-up structure = 6,000 lbs

Deck Volume = Length X Width X Depth = 30 ft X 15 ft. X 1.5 ft = 675 ft³

Mass Dispersion Factor = 6,000 lbs/675 ft³ = 8.88 lbs/ft³

Labor = cutting labor + fitting labor + welding labor = 1200 manhours

Labor factor = 1200 manhours/6,000 lbs = 0.2 manhours/lb

Minimizing weight does *not* necessarily minimize cost.



Density Measurements

- Mass Dispersion (component weight/enclosed volume) [lbf/ft³]
- Compensated Gross Tonnage (CGT)
- Percent Payload (weight of weapons / displacement) [%]
- Internal Density (group 200-700 weights/pressure hull volume) [lbf/ft³]
- **Arc-Permeability Factor (APF) (1-% floodable space) [%]**



- The volume *not* occupied by the items in a compartment is the *permeable* volume that could be flooded with water if a compartment was breeched.
- For our purposes, the fraction of volume occupied by items in a compartment will be referred to as the *Arc-Permeability Factor*.

ArcPermeability Factor = fraction of compartment occupied by items

ArcPermeability Factor = 1 – permeable volume fraction

Permeability represents an accurate means to measure density.



Permeability - Ship

1st Ship Shipbuilder Cost (CY07\$/LT) vs. Ship Arc-Permeability Factor

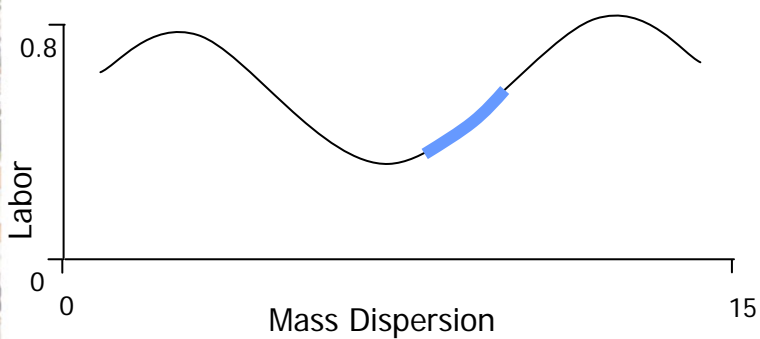
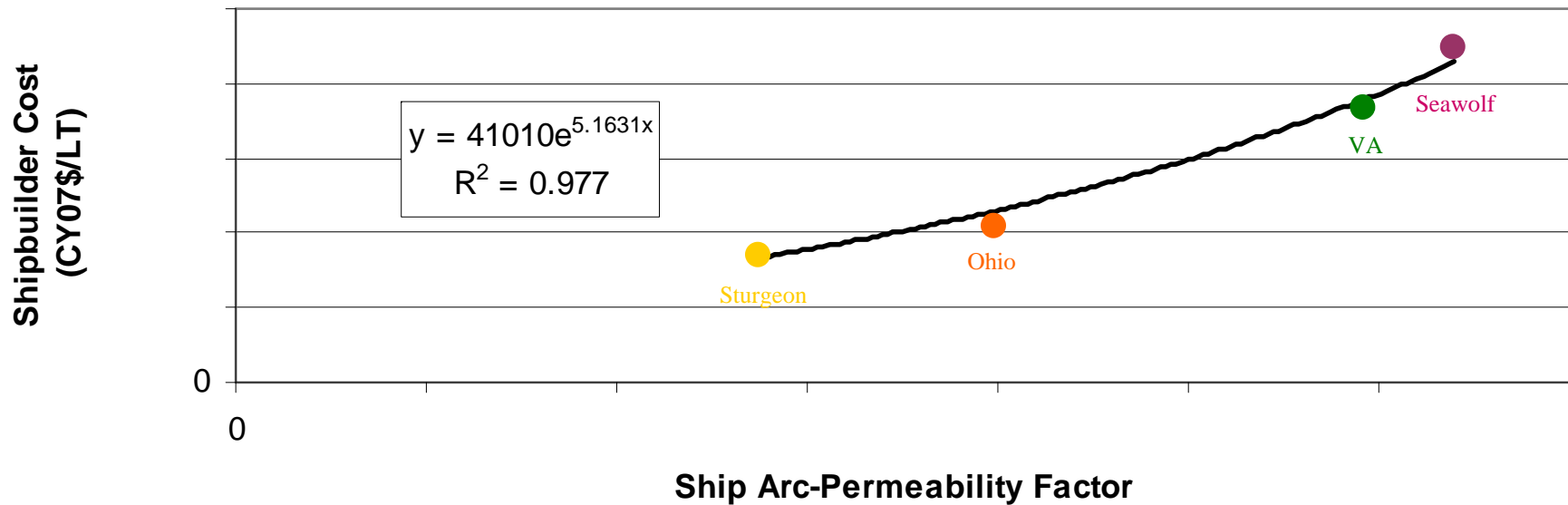

Strong positive correlation between Shipbuilder cost and Arc-Perm.



Capitalizing on the benefits of reduced density

- Avoid an acquisition strategy that is “stuck in the middle.”
- Make informed capability/flexibility tradeoff decisions.
- Give a voice to the Life Cycle Cost advocate.
- Enable meaningful comparisons among alternatives.



Recommendations/Next Steps

- Invest *more* in future flexibility and *less* in current capability.
- Employ Arc-Permeability Factor (APF) as the preferred measure of how tightly systems and equipment are placed within a compartment.
- Lay foundation for Naval vessel Compensated Gross Tonnage (CGT) factor determination using Arc-Permeability Factors (APF).
- Continue research to include density as a parameter in cost analysis of future submarine designs.
- Bring a potential end to historic SCN cost-growth in excess of inflation.



NAVAL
POSTGRADUATE
SCHOOL

Questions

The Nation's Premiere Defense Research University

Monterey, California
WWW.NPS.EDU





Compensated Gross Tonnage

Man-hours per CGT vs. FMI rating

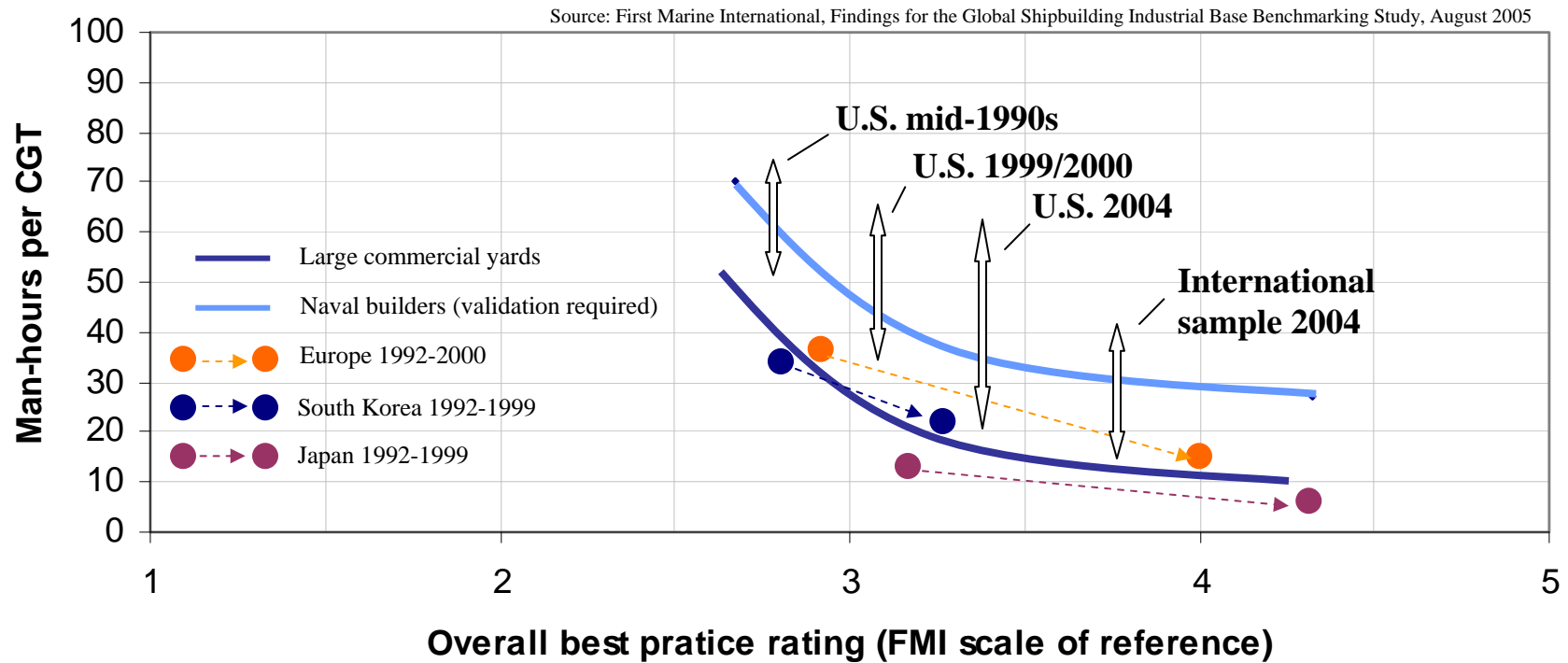

Compensated Gross Tonnage factors do not yet exist for naval vessels.



- We are at risk of getting *stuck in the middle*.
- We should invest *more* in future flexibility and *less* in current capability.
- Size and weight reduction are cost-saving measures that are *costing us*.
- Arc-Permeability Factor (APF) provides an excellent measure of how tightly systems and equipment are placed within a compartment.
- There is no *silver bullet* and there are no *sacred cows*.
- The design/build team should be expanded to a *design/build/test-once/operate/maintain/upgrade* team.



We are at risk of getting stuck in the middle

US Naval acquisition strategy is in danger of getting “stuck in the middle.”

US Naval Submarine Force Strategic Position

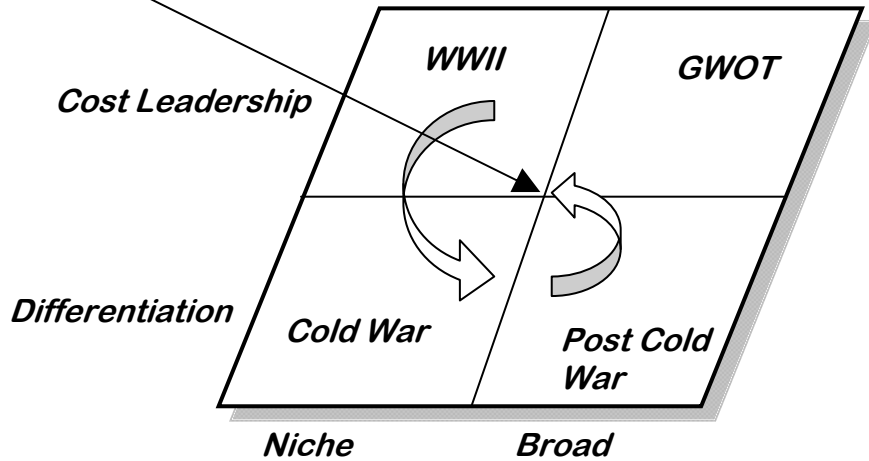

US Naval Submarine Force Innovations

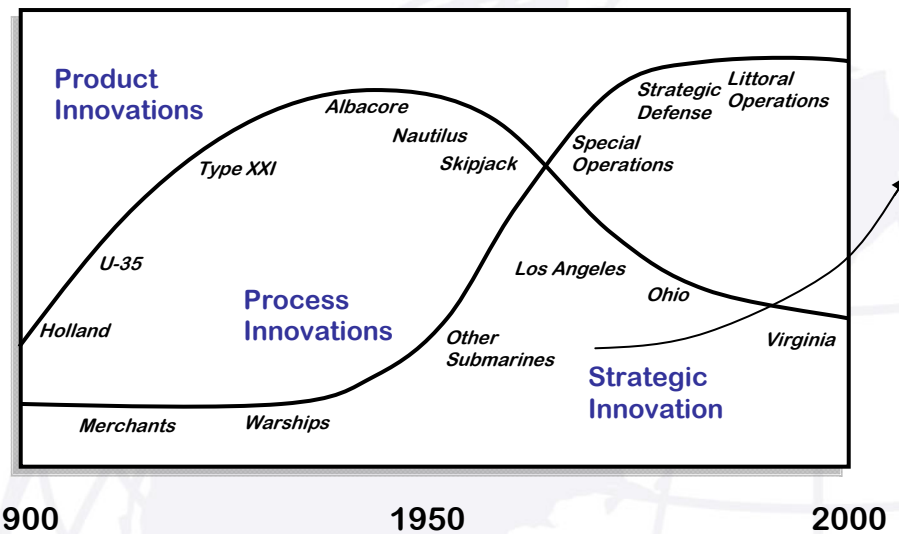

US Naval Submarine Force Strategic Position

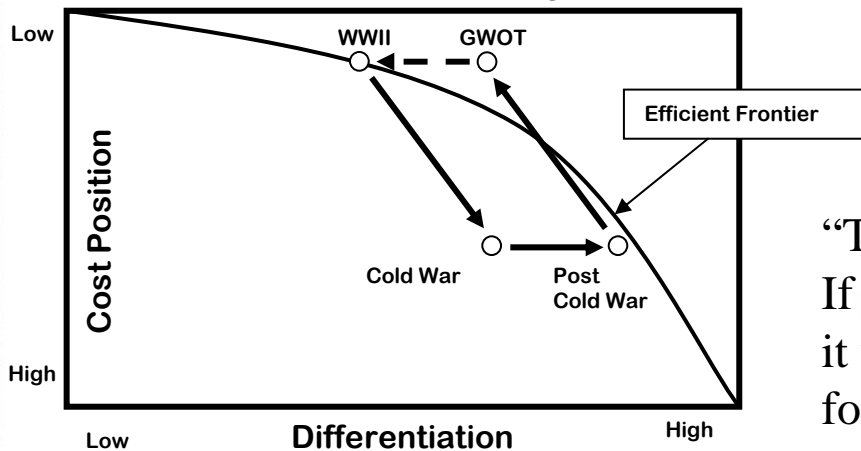

“The middle way is no way at all. If we finally fail in this great and glorious contest, it will be by bewildering ourselves in groping for the middle way.”

– John Adams, 1776 15



Reasons to invest in the future...

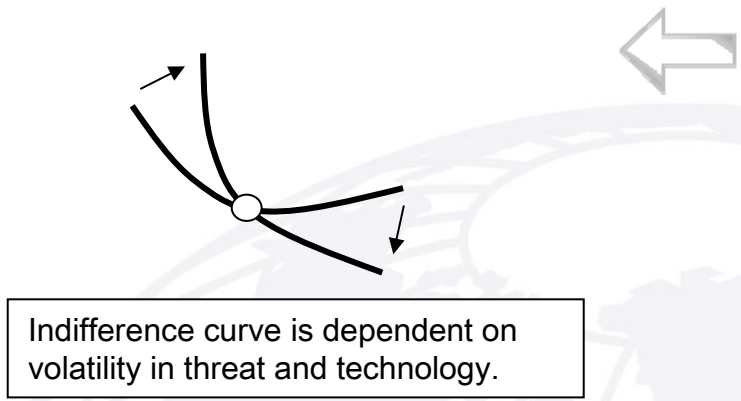
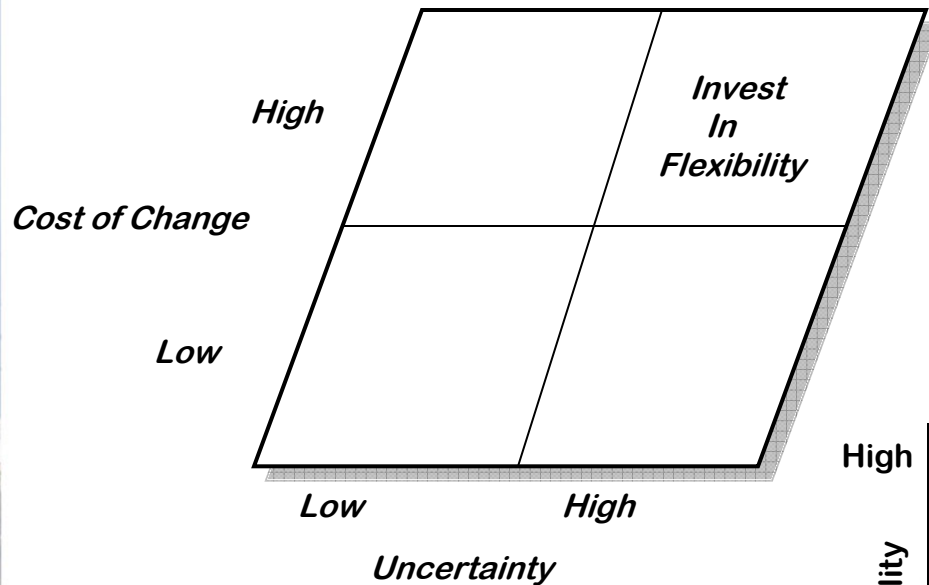

“Sometimes capacity is a capability.”

- VADM McCullough

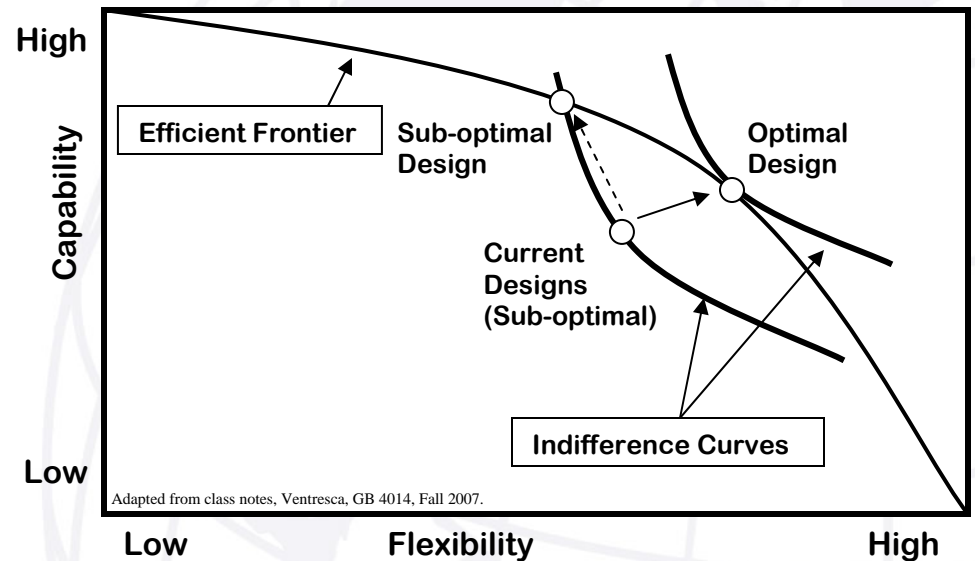

The optimal balance is shifting from capability toward flexibility.



Density



Density:

Definition:

$$\textit{Submarine Density} = \frac{\textit{weight of interior systems \& equipment}}{\textit{volume of submarine interior}}$$

Approximation:

$$\textit{Submarine Density} \approx \frac{\textit{Group 200 thru 700 weights}}{\textit{volume of pressure hull}}$$

Alternate Form:

$$\textit{Specific Gravity} \approx \frac{\textit{Submarine Density}}{\textit{Density of H}_2\textit{O @ 70}^\circ\textit{F}}$$



- Congressional Research Service (CRS) report entitled *Navy Ship Acquisition: Options for Lower-Cost Ship Designs—Issues for Congress* dated June 23, 2005
 - reduce ship size
 - shift from nuclear to conventional propulsion
 - shift from a hull built to military survivability standards to a hull built to commercial-ship survivability standards
 - use a common hull design for multiple classes of ships
- *Why Has the Cost of Navy Ships Risen?* (Rand Corporation, 2006)
 - “In general, a larger and more complex ship will cost more than a simpler one.”
 - “LSW is a proxy for size. Larger ships should cost more than smaller ships, other things being equal (same functionality, class, etc.)”
- Roy Burcher and Louis Rydill in their book Concepts in Submarine Design (Cambridge University Press, 1994)
 - “There is a temptation to speculate whether submarines would be cheaper to build if they were made larger and less congested, but although the instincts of many who have been involved in design and building submarines lead them to believe that could be so, it is difficult to prove or demonstrate.”