

NPS-AM-11-C8P12R03-050



# EXCERPT FROM THE PROCEEDINGS

---

OF THE  
EIGHTH ANNUAL ACQUISITION  
RESEARCH SYMPOSIUM  
WEDNESDAY SESSIONS  
VOLUME I

**In-Service Support of Surface Navy Combat Systems: Safety,  
Effectiveness, and Affordability Reviews: The Systems Engineering  
Process at NSWC PHD**

CDR Stephen Meade, Kris Hatakeyama, Juan Camacho, Karen Brower,  
and Dave Scheid, USN, Naval Surface Warfare Center Port Hueneme  
Division

**Published: 30 April 2011**

Approved for public release; distribution unlimited.

Prepared for the Naval Postgraduate School, Monterey, California 93943

Disclaimer: The views represented in this report are those of the authors and do not reflect the official policy position of the Navy, the Department of Defense, or the Federal Government.



ACQUISITION RESEARCH PROGRAM  
GRADUATE SCHOOL OF BUSINESS & PUBLIC POLICY  
NAVAL POSTGRADUATE SCHOOL

The research presented at the symposium was supported by the Acquisition Chair of the Graduate School of Business & Public Policy at the Naval Postgraduate School.

**To request Defense Acquisition Research or to become a research sponsor, please contact:**

NPS Acquisition Research Program  
Attn: James B. Greene, RADM, USN, (Ret.)  
Acquisition Chair  
Graduate School of Business and Public Policy  
Naval Postgraduate School  
555 Dyer Road, Room 332  
Monterey, CA 93943-5103  
Tel: (831) 656-2092  
Fax: (831) 656-2253  
E-mail: [jbgreene@nps.edu](mailto:jbgreene@nps.edu)

Copies of the Acquisition Sponsored Research Reports may be printed from our website  
[www.acquisitionresearch.net](http://www.acquisitionresearch.net)



ACQUISITION RESEARCH PROGRAM  
GRADUATE SCHOOL OF BUSINESS & PUBLIC POLICY  
NAVAL POSTGRADUATE SCHOOL

## Preface & Acknowledgements

---

During his internship with the Graduate School of Business & Public Policy in June 2010, U.S. Air Force Academy Cadet Chase Lane surveyed the activities of the Naval Postgraduate School's Acquisition Research Program in its first seven years. The sheer volume of research products—almost 600 published papers (e.g., technical reports, journal articles, theses)—indicates the extent to which the depth and breadth of acquisition research has increased during these years. Over 300 authors contributed to these works, which means that the pool of those who have had significant intellectual engagement with acquisition issues has increased substantially. The broad range of research topics includes acquisition reform, defense industry, fielding, contracting, interoperability, organizational behavior, risk management, cost estimating, and many others. Approaches range from conceptual and exploratory studies to develop propositions about various aspects of acquisition, to applied and statistical analyses to test specific hypotheses. Methodologies include case studies, modeling, surveys, and experiments. On the whole, such findings make us both grateful for the ARP's progress to date, and hopeful that this progress in research will lead to substantive improvements in the DoD's acquisition outcomes.

As pragmatists, we of course recognize that such change can only occur to the extent that the potential knowledge wrapped up in these products is put to use and tested to determine its value. We take seriously the pernicious effects of the so-called “theory–practice” gap, which would separate the acquisition scholar from the acquisition practitioner, and relegate the scholar's work to mere academic “shelfware.” Some design features of our program that we believe help avoid these effects include the following: connecting researchers with practitioners on specific projects; requiring researchers to brief sponsors on project findings as a condition of funding award; “pushing” potentially high-impact research reports (e.g., via overnight shipping) to selected practitioners and policy-makers; and most notably, sponsoring this symposium, which we craft intentionally as an opportunity for fruitful, lasting connections between scholars and practitioners.

A former Defense Acquisition Executive, responding to a comment that academic research was not generally useful in acquisition practice, opined, “That's not their [the academics'] problem—it's ours [the practitioners']. They can only perform research; it's up to us to use it.” While we certainly agree with this sentiment, we also recognize that any research, however theoretical, must point to some termination in action; academics have a responsibility to make their work intelligible to practitioners. Thus we continue to seek projects that both comport with solid standards of scholarship, and address relevant acquisition issues. These years of experience have shown us the difficulty in attempting to balance these two objectives, but we are convinced that the attempt is absolutely essential if any real improvement is to be realized.

We gratefully acknowledge the ongoing support and leadership of our sponsors, whose foresight and vision have assured the continuing success of the Acquisition Research Program:

- Office of the Under Secretary of Defense (Acquisition, Technology & Logistics)
- Program Executive Officer SHIPS
- Commander, Naval Sea Systems Command
- Army Contracting Command, U.S. Army Materiel Command
- Program Manager, Airborne, Maritime and Fixed Station Joint Tactical Radio System



- Program Executive Officer Integrated Warfare Systems
- Office of the Assistant Secretary of the Air Force (Acquisition)
- Office of the Assistant Secretary of the Army (Acquisition, Logistics, & Technology)
- Deputy Assistant Secretary of the Navy (Acquisition & Logistics Management)
- Director, Strategic Systems Programs Office
- Deputy Director, Acquisition Career Management, US Army
- Defense Business Systems Acquisition Executive, Business Transformation Agency
- Office of Procurement and Assistance Management Headquarters, Department of Energy

We also thank the Naval Postgraduate School Foundation and acknowledge its generous contributions in support of this Symposium.

James B. Greene, Jr.  
Rear Admiral, U.S. Navy (Ret.)

Keith F. Snider, PhD  
Associate Professor



## Panel 12 – DoD Field Activities as Enablers of the Defense Industrial Base: A Navy Example

---

Wednesday, May 11, 2011	
3:30 p.m. – 5:00 p.m.	<p><b>Chair: Dohn Burnett</b>, Head, Warfare Systems Department, Naval Surface Warfare Center Dahlgren Division</p> <p><b><i>Department of Defense Field Activities as Enablers of the Defense Industrial Base for the Acquisition of Surface Navy Combat Systems</i></b></p> <p>H. Glenn Woodard, Warren Lewis, Gilbert Goddin, and Wendy Schaeffer, Naval Surface Warfare Center Dahlgren Division</p> <p><b><i>Department of Defense Field Activity Roles as Enablers for the Industrial Base: Naval Laboratory Analysis that Supports Key Acquisition Decisions</i></b></p> <p>Steve Sovine, Lorilee Geisweidt, Nathan Miller, and Dave Clawson, Naval Surface Warfare Center Dahlgren Division</p> <p><b><i>In-Service Support of Surface Navy Combat Systems: Safety, Effectiveness, and Affordability Reviews: The Systems Engineering Process at NSWC PHD</i></b></p> <p>CDR Stephen Meade, Kris Hatakeyama, Juan Camacho, Karen Brower, and Dave Scheid, USN, Naval Surface Warfare Center Port Hueneme Division</p>



# In-Service Support of Surface Navy Combat Systems: Safety, Effectiveness, and Affordability Reviews: The Systems Engineering Process at NSWC PHD

**Stephen Meade**—CDR Meade was born and raised in Upper Marlboro, Maryland. He graduated from North Carolina State University in 1993 with a Bachelors of Science in Materials Science and Engineering and was commissioned in the U.S. Navy through the ROTC program. CDR Meade received his Masters of Science in Applied Physics with a focus on Electromagnetic Sensors from the Naval Postgraduate School. CDR Meade is currently assigned as the Air Dominance Department Officer at NSWC Port Hueneme Division. He has completed a dual degree program for a MBA and MS in Program Management from the University of Maryland, University College. He has also earned his Level III DAWIA certification in Test and Evaluation as well as System Planning, RD&E–Systems Engineering.

**Kris Hatakeyama**

**Juan Camacho**

**Karen Brower**

**Dave Scheid**

## Abstract

Many DoD Field Activities have been designated as In-Service Engineering Agents (ISEAs) for individual warfighting systems. As ISEA, it is crucial to periodically assess system capabilities and limitations individually, as a class, and as a strike force, as well as the technical community's ability to support the systems in question. Issues resulting from these assessments must be brought forward and addressed in an appropriate manner. From an acquisition perspective, limitations that require materiel solutions must be fed through the Navy's budgeting process so that focused and coordinated engineering efforts can be undertaken. These issues must be provided across the acquisition and technical community, including the industrial base, so that they can influence change in the design of systems.

An example of this ISEA assessment is the Naval Surface Warfare Center Port Hueneme Division (NSWC PHD) Safety, Effectiveness, and Affordability Review (SEAR) process. NSWC PHD conducts In-Service Engineering (ISE) which demands the rigorous and continual application of well-structured, systematic processes that, at their core, are integrated as a Systems Engineering approach. According to the Acquisition and Capabilities Guidebook, a Systems Engineering Plan (SEP) is a mandatory milestone document that is required at milestones A, B, and C and also program initiation for ships" (SECNAV, 2008). One of the biggest challenges to the SEP is how to maintain the discipline for not only the Milestones, but also over the systems Lifecycle, and to maintain the Safety, Effectiveness and Affordability of each system. This requires continuous vigilance, starting with subject matter experts looking at the reams of data that support the condition of the systems, boiling it down to systemic trends that have adverse effect on the mission, and finally developing solutions that not only fix the issues, but are affordable over the lifecycle and can be fed back into the design. This continuous loop of disciplined systems engineering rigor is the cornerstone of maximizing mission performance capability. This information must be utilized by the acquisition and technical communities to



improve the design and capabilities of our systems. This effort includes training, logistics, and maintenance. Maintenance and upgrade of these programs is critical to keeping warships relevant, reducing obsolescence, and increasing commonality. This will also improve fleet readiness and fleet interoperability.

This paper will focus on the process of periodic Safety, Effectiveness, and Affordability reviews at the equipment, system, platform, and battle group levels to identify drivers that reduce readiness and/or interoperability in the current fleet and push recommended fix plans into the Navy acquisition process for program updates. It also will allow the acquisition and operational communities to make more effective and efficient decisions on funding affecting the Navy's budgetary cycles. SEAR data provides a critical quantifiable perspective to decision makers to make better acquisition decisions. This information must be shared with industry as well, so that they can incorporate it into their planning, development, engineering, manufacturing, and production. This facilitates development and promulgation of significant lessons learned across the government and industry team, and initiates the appropriate changes to technical procedures, requirements, standards, and policies.

## **Purpose**

The purpose of this paper is to outline why the Safety, Effectiveness, and Affordability Review (SEAR) process is foundational and necessary for the Naval Surface Warfare Center, Port Hueneme Division (NSWC PHD) to effectively execute its role as an In-Service Engineering Agent (ISEA) and to give a brief overview of the process and its core elements. It will also show how this process needs to be expanded and shared across the other engineering agents, acquisition community, and industry.

## **Background**

The In-Service Engineering Agent (ISEA) has always been focused on the functions of maintaining Combat System Safety and Effectiveness. In today's environment of budget constraints, rapid introduction of commercial off-the-shelf (COTS) equipment, and associated obsolescence issues, Affordability is also a critical focus area. Not only is a system level review of these areas beneficial, but the operational concerns with interoperability necessitates a platform level review.

NSWC PHD has been conducting Safety, Effectiveness, and Affordability Reviews (SEAR) of the Combat System Elements for which they are responsible as ISEA. They have also been conducting platform level SEARs with all of the systems under their cognizance. The SEAR process is aligned with the tasking from Naval Sea Systems Command (NAVSEA) and the Program Executive Offices (PEOs). This includes providing the technical insight and compliance with requirements, standards, and policies with recommendations on significant technical issues. NSWC PHD is also tasked with facilitating the development and promulgation of lessons learned and initiation of appropriate changes. The systems engineering approach used at NSWC PHD could be utilized across other engineering agents, as well as industry, to provide a more robust and holistic system and platform level review that would be more beneficial to the program offices.

The quality and overall value of NSWC PHD contributions to the customer are primarily reflected in the degree to which the safety, effectiveness, and affordability of in-service weapon systems, combat systems, ship classes, and carrier/expeditionary strike groups/forces are improved over time by products and services delivered to the Fleet. The



data and analysis generated in a SEAR provides valuable insight into the system and platform for the program office. It would also be valuable to the other engineering agents, in particular, the Design Agent and the Original Equipment Manufacturer (OEM). The metrics, analysis, and recommendations help maintain a viable system throughout its lifecycle. It also provides critical feedback into the design and acquisition process, which could help reduce Total Ownership Cost (TOC). To achieve the optimal return on investment for process and product quality improvements, SEARs need to be documented in sufficient detail at the appropriate frequency. The SEAR process is the underlying closed loop systems engineering process that is the backbone of NSWC PHD's methods for achieving the highest quality blend of products and services.

The SEAR addresses the safety metrics of a system with regards to risks, hazards, and incidents. The effectiveness is reviewed from the perspective of the Probability of Capability ( $P_c$ ), Operational Availability ( $A_o$ ), and the People Factor ( $P_p$ ). The affordability section relates the safe and effective metrics to the cost as a subset of TOC. Cost drivers and cost savings/avoidances are discussed. Interoperability and System Integration are reviewed with regards to the safety and effectiveness of the interfaces and relationships inside and outside the lifelines of the system. Lastly, metrics on how well NSWC PHD is performing are reviewed in the areas of Fleet Responsiveness, Product Timeliness, and Integrated Logistics Assessment.

## **Current State Approach and Challenges**

### ***The SEAR Process—The Foundation of In-Service Engineering***

NSWC PHD performs a multitude of in-service engineering roles encompassing all levels of concern from the equipment level through combat systems, ship class by warfare area, and finally, carrier/expeditionary strike groups/forces. The SEAR process is the disciplined systems engineering method applied at each level to ensure that a consistent approach is used to collect, analyze, and display data and information. The goal is to provide the recurring assessments, analysis, and identification of issues and recommendations to the larger acquisition community and technical community. For example, the SEAR process ensures that only authoritative data sources are employed and that only authoritative requirements are used, against which to measure the various SEAR process metrics. The process also “cross pollinates” practices across organization boundaries, resulting in best-of-breed practices to be adopted by the organization at large.

In order for NSWC PHD to effectively accomplish its in-service engineering tasking, the systems engineering process must also accommodate aggregating data and information for use at the next higher level. That is, a closed loop systems engineering process must “roll up” data from a combat system to a warfare area, or from individual platforms of a ship class to the carrier/expeditionary strike group level. The process must also accommodate “drill down,” that is, the ability to reach underlying information that supports conclusions made at a higher level. Only by adhering to this process can NSWC PHD develop and maintain the integrated “big picture” needed to support today’s Fleet.

By conducting the robust systems engineering analysis, critical design considerations are addressed throughout the acquisition lifecycle, which will have major impacts on TOC and will help deliver a combat system with affordable operational effectiveness. Acquisition decisions and design tradeoffs are made with capabilities and functions that affect system performance against specifications and requirements, often at the expense of technical effectiveness and system effectiveness. Fully understanding these





design considerations that affect the reliability, maintainability, supportability, producibility, operations, maintenance, and logistics is essential to improving the availability and efficiencies of the system. This will lead to reaching optimal technical and system effectiveness. When analyzed in the context of how these affect lifecycle cost and TOC, the resultant will be a more affordable and operationally effect system (see Figure 1). The SEAR process provides the necessary systems engineering rigor from an In-Service perspective to be able to provide positive impact on the acquisition lifecycle and design of combat systems.

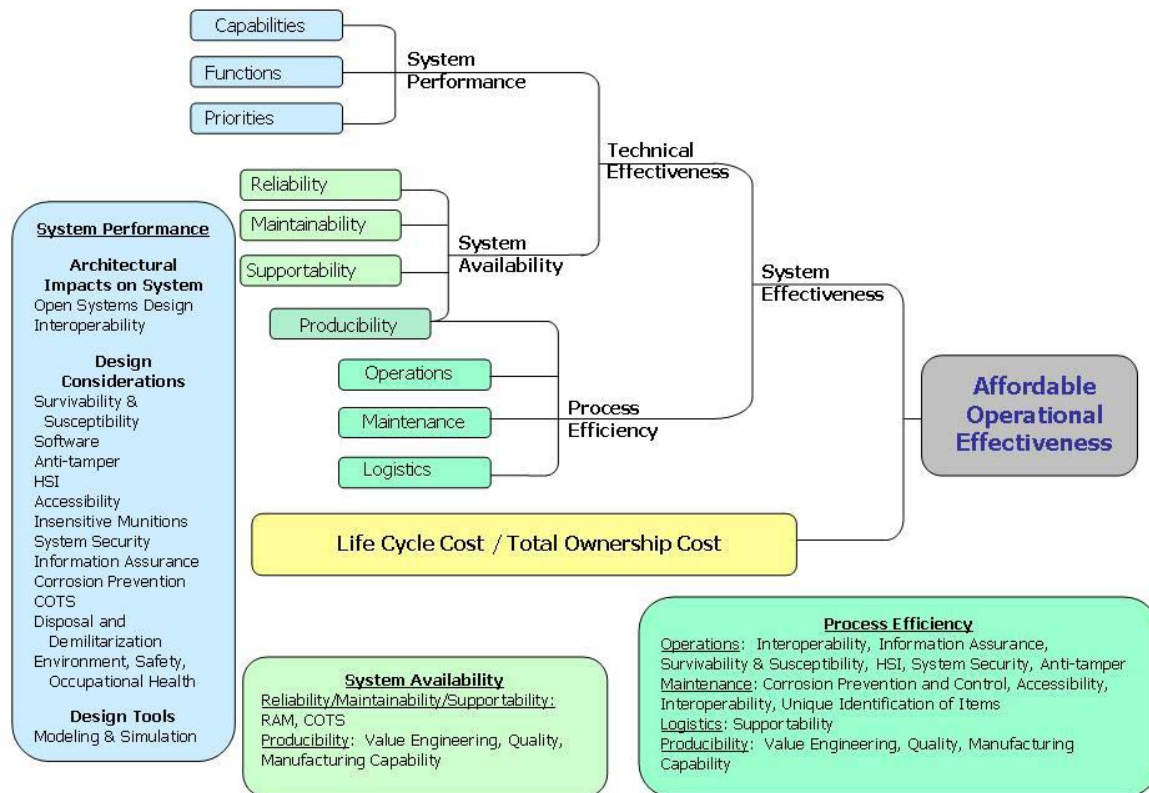

**Figure 1. Important Design Consideration for Affordable Operation Effectiveness**

The general guidance in conducting the SEARs is to analyze the system effectiveness based on the design/performance requirements or specifications, key performance parameters, key system attributes, and current mission requirements. The  $P_c$ ,  $P_p$ , and  $A_o$  parameters should be determined individually by baseline and by block type, depending on the system. Because of the complexity in the higher level platform SEARs, the analysis, perspective, and approaches may be different. Issues at the lower level may be lost or not visible when aggregated, due to redundancies or differences in higher level requirements. The review must contain the impacts of commercial items and non-developmental items. The analysis must also take into consideration the key logistic elements that impact the areas being reviewed. The cornerstone of the SEAR is to review these on an annual basis with the engineering rigor in the analysis to identify trends, and then to be proactive in providing feedback to the technical and acquisition community in a

closed loop process (see Figure 2). The output of the SEAR process provides NSWC PHD the ability to make informed recommendations and decisions required by Fleet and program office customers. It is also an opportunity to feedback to industry to affect change and improvements in the products and services they provide the government.

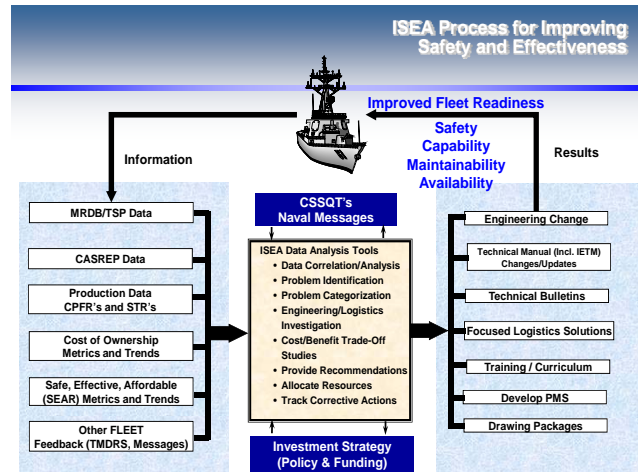

Figure 2. Closed Loop Engineering Process

## Brief Overview of SEAR Process Elements

### Safety

Safety, as defined by the NSWC PHD SEAR Guide, is the freedom from those conditions that can cause death, injury, occupational illness, damage to or loss of equipment or property, or damage to the environment. System Safety Programs are usually established in accordance with MIL-STD-882E. In the context of the SEAR process, it represents the level to which risks of injury or damage (hazards) to personnel and equipment have been mitigated, as shown in Figure 3. The safety element is used to validate the continued safety of fielded systems and follows these steps:

- Review the process and results of incorporating safety into the design.
- Identify those processes that ensure safety during operation and maintenance of the equipment or system in the fleet.
- Conduct a Safety Stand-Down prior to each Safety, Effectiveness, and Affordability review.
- Develop a Risk Matrix chart categorizing each safety issue. The sample chart (Figure 4) shows the number of issues by category and the acceptance authority action required.

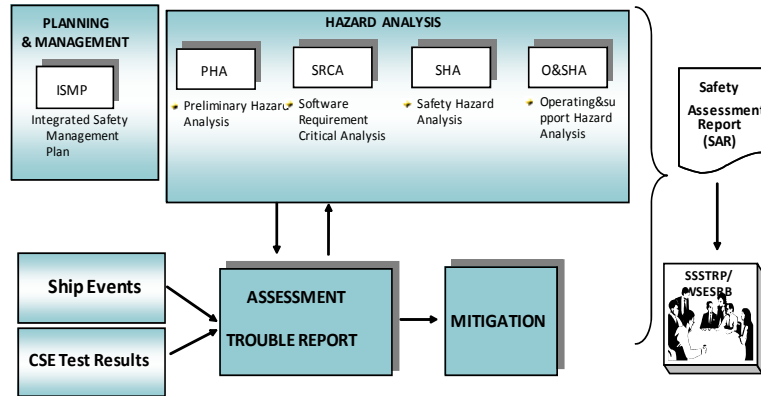

**Figure 3. Safety Process**

Hazard Probability	Hazard Severity Category			
	1. Catastrophic	2. Critical	3. Marginal	4. Negligible
A. Frequent				
B. Probable	1			
C. Occasional	2		1	
D. Remote	3	4	2	2
E. Improbable	16	3		
Mishap Risk Index	Risk Level	Acceptance Authority		
1A, 1B, 1C, 2A, 2B	High	Unacceptable (Must be resolved)/ PEO		
1D, 2C, 3A, 3B	Serious	Undesirable/ PEO		
1E, 2D, 2E, 3C, 3D, 3E, 4A, 4B	Medium	Acceptable with Safety Manager Review		
4C, 4D, 4E	Low	Acceptable without review		

**Figure 4. Sample Safety Risk Matrix**

NSWC PHD, as the Combat System In-Service Engineering Agent (ISEA), needs to maintain awareness of all safety issues, document them thoroughly, and address them in a timely and effective manner. These actions result in safer weapons systems and reduce losses of life, limb, and property. The SEAR Safety process supports PHD’s ability to make informed assessments of Fleet issues and to share information with all stakeholders. It helps promote best practices across organizational boundaries and maintain awareness of all safety issues impacting a system or a system of systems (SoS) by informing the fleet of all safety hazards and initiating and implementing appropriate corrective actions.

**Effectiveness**

Effectiveness is defined as a function of the Probability of Capability ( $P_c$ ), Operational Availability ( $A_o$ ), and Probability of Personnel ( $P_p$ ; also known as the *people factor*). Each aspect of Effectiveness is analyzed in several of the primary warfare mission areas. Addressing more of the primary mission areas for a more holistic understanding of the Effectiveness is an opportunity to improve the process. An example of the mission areas covered in a typical Platform SEAR is highlighted in Figure 5.

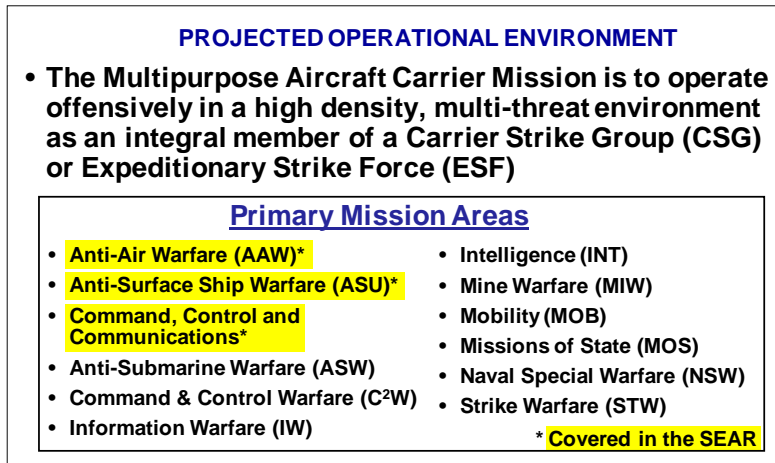

**Figure 5. Mission Areas Covered in a Typical Platform SEAR**

**Capability:  $P_c$**

Probability of Capability is defined as the inherent ability of weapon system, combat system, ship class, or carrier/expeditionary strike group/force to perform a mission. The impacts of equipment and computer program reliability failures or human errors are not included. In the context of the SEAR process, this definition recognizes that capability can only be determined within the framework of specific threats and specific environments.

The process steps are as follows:

- Understand what the expectations are for the system under analysis, as defined in the performance requirements.
- Identify the current mission requirements and the environment in which the system operates.
- Address computer program and interface limitations with other systems.

Results from the SEAR  $P_c$  assessment are used to identify areas of improvement, or to highlight the lack of testing resources to fully assess a mission area capability. The SEAR  $P_c$  assessment results are also used to develop and implement operational guidance that makes maximum use of the inherent performance capability, while minimizing the negative impact of system “weaknesses.” Negative impact is minimized by the ISEA developing firing guidance, implementation of equipment or system upgrades, process improvements, and improvement of technical documentation.

**Operational Availability:  $A_o$**

Operational availability is defined as the likelihood that when required, a system is operating at a pre-defined performance level and for a sufficient duration of time to accomplish the mission. In the context of the SEAR process,  $A_o$  is examined as both a lagging and leading indicator. The following items are performed to calculate a system and platform  $A_o$ :

- $A_o$  is calculated at the System/Equipment levels.
- The measured values should be compared to values contained in design/performance requirements or specifications (i.e., Weapons

Spec/Ordnance Spec) for newer systems and to past history for all systems (when available).

- For the purposes of SEAR,  $A_o$  is calculated using critical and major failures only.
- At the platform level, the first step is to define the reliability block diagram for the detect, control, and engage systems within the combat system. An example is illustrated in Figure 6.
- Given the mission of the platform and the types of threats expected to be encountered, an availability analysis is conducted given hard and soft kill alternatives along with conclusions and recommendations.

## AD Ao Model

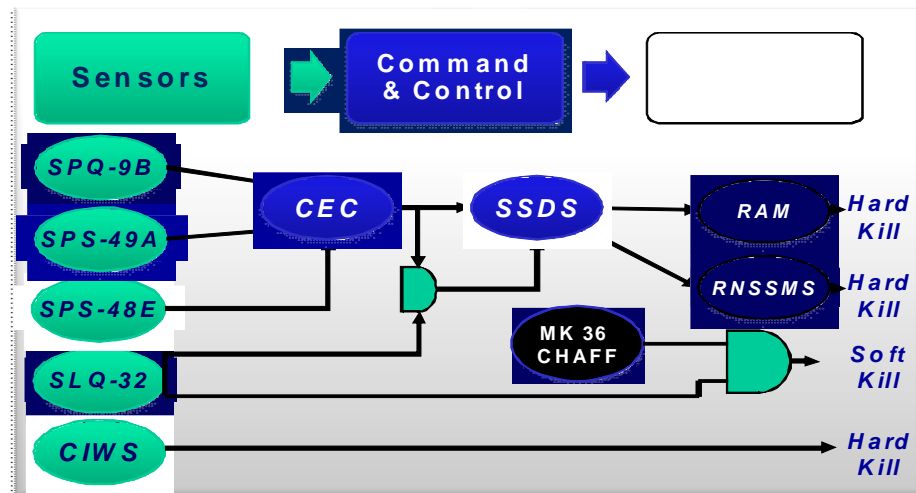

**Figure 6. Example of Air Defense (AD)  $A_o$  Model Reliability Block Diagram Process**

While NSWC Corona is the responsible agent for calculating  $A_o$  values, it is the ISEA that interprets this data and determines the causes of availability trends. The communication and relationship between NSWC Corona and PHD are critical for successful SEAR implementation. The ISEA develops solutions and/or provides recommendations to address availability problem drivers. Results of the SEAR  $A_o$  assessment process can lead to the development of system or equipment upgrades that increase reliability, increase maintainability, or implement logistics changes that improve supportability.

### **People Factor: $P_p$**

Probability of Personnel, or people factor, encompasses the human systems integration factors in mission performance. It examines the human performing all the necessary steps on time to properly maintain, set up, and operate one or more systems and complete the mission. In the context of the SEAR process, the people factor can be a quantitative assessment (ship manning levels) and/or a qualitative assessment (correct NECs and proper training).  $P_p$  is comprised of five factors that, while often not directly measurable, can be tracked for trend-finding purposes.

The process steps are as follows:

- Assess Ergonomics: Personnel safety and “usability” of operation and maintenance procedures are components of the Ergonomics element.
- Assess Crew Experience
- Assess Staffing/Manning Level
- Assess Personnel Availability
- Assess Training

Analysis of P<sub>p</sub> data can result in findings within Personnel Training that result in a direct tie to other areas such as Availability or related trends (proper system maintenance or operation, personnel qualifications, manning levels, INSURV results). The types of metrics collected and assessments generated are illustrated in Figures 7 and 8.

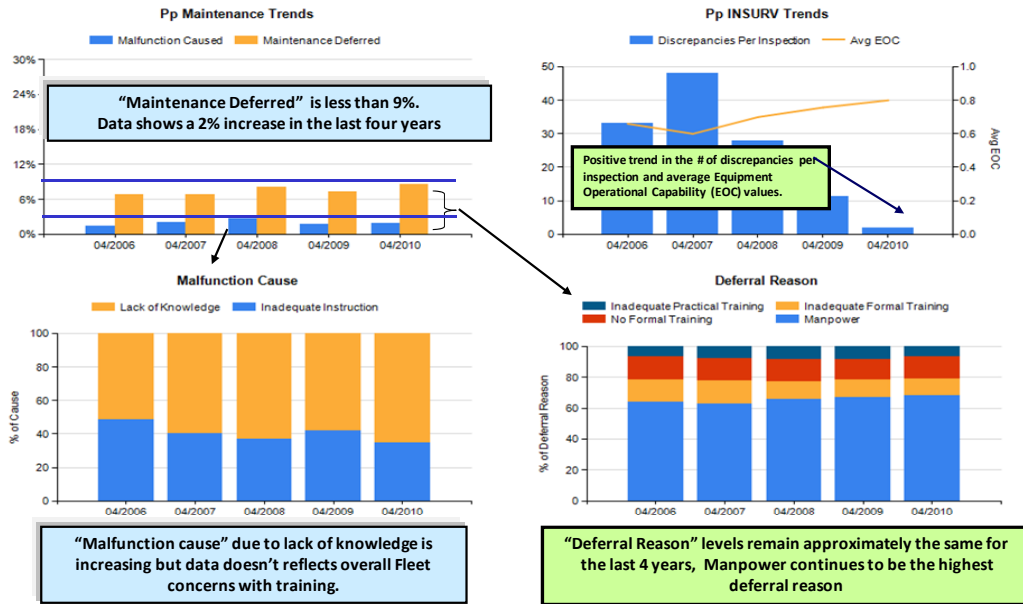

Figure 7. Example Personnel Metrics

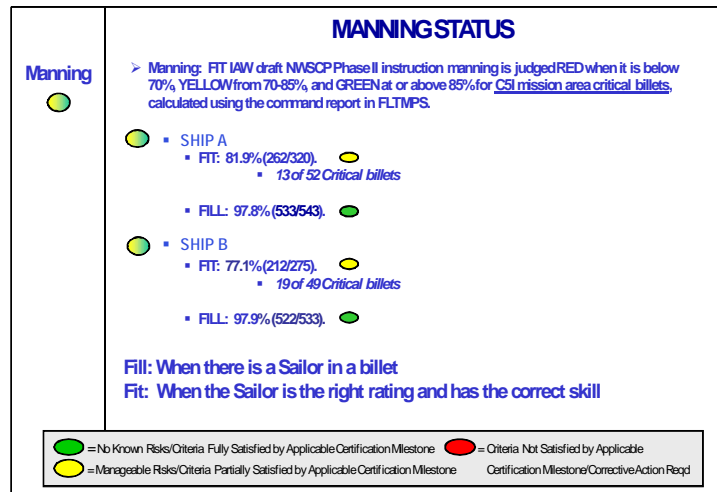

Figure 8. Example of PP Analysis on Manning Status



The following are examples of how the SEAR P<sub>P</sub> assessment results add value to the conduct of Combat System Ship Qualification Trials (CSSQTs), Test and Evaluation, and Fleet training events:

1. The shipboard training process can be modified based on pre commissioning unit (PCU) training results obtained from the Aegis Training Readiness Center (ATRC). Shipboard training would then be tailored to the needs of that particular crew. Results from at-sea test events can help identify weaknesses not only in team training, but also in an individual sailor training pipeline. This can be provided to the training community for continuous process improvements.
2. As the data from multiple exercises becomes available, the opportunity to make objective judgments on the results of these exercises will better reflect the operational capabilities of people and systems. Personnel manning and formal training levels are areas outside the direct control of the ISEA. However, consistent shortfalls in these areas can be documented and addressed, via the SEAR P<sub>P</sub> process, to the detailing, training, and Program Office communities to influence these personnel issues.
3. Consistently weak areas should be analyzed from a system standpoint. System requirements that overburden or are confusing to an operator should be addressed from a hardware or software standpoint, as required. Recommended changes can then be documented and/or implemented to maintain and improve a systems maintenance and operational readiness.
4. Deficiencies that cannot be attributed to system capabilities can also be analyzed. Those that have consistency across platforms should be reviewed in relation to the training process and changes made. Opportunities for these changes are available in the review of formal training courses by ISEA personnel, ISEA inputs to tactical and IETM documentation development process, and the modification of on-site training to ensure weak areas are addressed.

For those areas that are random vice symptomatic (one-time deals), additional training can be provided as the opportunities in CSSQT or Combat System Certification evolutions present themselves. The results of these additional training efforts can then be documented, and changes implemented as necessary in technical manuals and in documents providing operational guidance, such as Tactical Memorandums (TACMEMOs).

## **Affordability**

Affordability is the relationship of the SEAR process elements to cost. In the context of the SEAR process, the goal of examining affordability is to apply TOC methodology in identifying cost drivers and tracking cost trends that NSWC PHD can affect.

The process steps are as follows:

- Examine data utilized by the Fleet and Program Managers to assess affordability.
- Examine personnel requirements.
- Report Cost Savings/Avoidance Initiatives.



Analysis of Affordability data allows for identification of trends in systems costs to the Fleet and variances in costs across various ship classes, baselines, and system variants. Examples are shown in Figures 9 and 10.

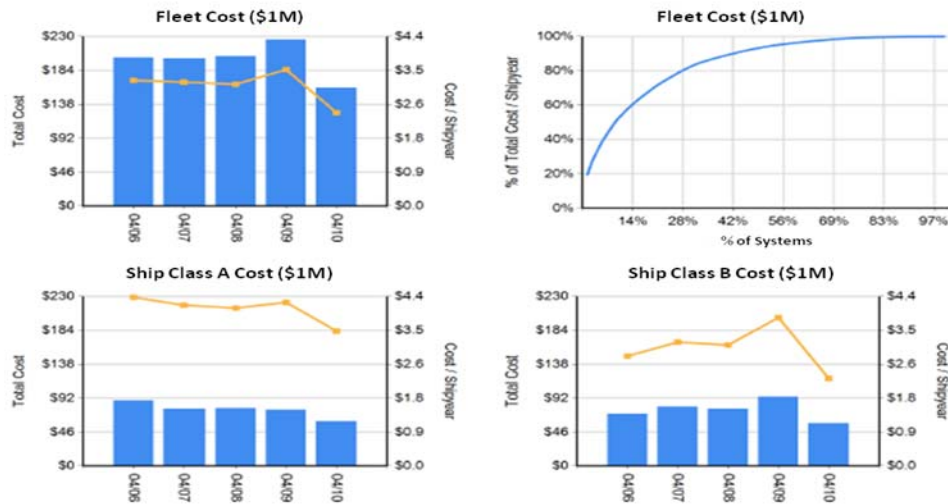

**Figure 9. Sample of Affordability Data**

**ANTENNA RESTORATION**

- **ISSUE**—
  - Antenna age, corrosion and cable cracking
    - Antenna installed in June 2001
    - During Material Condition Assessment, PHD found corrosion on several Antenna assemblies, crated cabling and paint degradation
- **RESOLUTION**—
  - ISEA, working with the depot and the OEM, conducted first ever in place Antenna restoration during ships PSA
    - Replaced Antenna Radomes and Pedestal Electronics Assembly
    - Replaced all external Pedestal waveguide
    - Replaced and weatherized all internal and external cabling
    - Replaced Azimuth Drive Motor
    - Removed corrosion, repainted and re-stenciled Antenna pedestal foundation and Antenna pedestal
  - Significant cost saving achieved versus full Antenna overhaul
    - Antenna did not have to be craned off of ship, broken apart, crated and sent to overhaul facilities and returned / re-installed
    - Antenna alignments did not need to be re-performed

**Figure 10. Example of Cost Savings Initiatives Reported in a SEAR**

The ISEA adds value by assisting Program Sponsors and the Fleet in achieving their cost reduction goals, such as the following improvement package that was submitted for “Top Cost” AN/SPY-1 parts:

1. High Voltage Power Supply (HVPS) Inverter Module: Ship change document (SCD) 4603 adds fault detection to limit inverter failure;
2. Phase Shift Driver (PSD) re-design has lower failure rate; and
3. Electronic Switch 2-M repair authorized.





## Interoperability/System Integration

Interoperability is the ability of equipment, combat systems, ship classes, or carrier/expeditionary strike groups/forces to provide services to and accept services from other equipment, combat systems, ship classes, or carrier/expeditionary strike groups/forces, and to use those services to operate effectively together and to achieve assigned missions. System integration is the progressive linking and testing of system components to merge their functional and technical characteristics into a comprehensive, interoperable system. In the context of the SEAR process, interoperability refers to interfaces/relationships “outside the lifelines,” while system integration refers to interfaces/relationships “inside the lifelines.”

The process steps are as follows:

- Collaborative Assessment by NAVSEA Interoperability Certification Committee (ICC), augmented by Subject Matter Experts & Fleet users;
- Reviewed results from land based tests & underway events;
- Issues affecting interoperability analyzed, assessed and mapped to essential functions and corresponding mission areas;
- Qualitative Assessment based on;
- Quantity and severity of issues considered;
- Fleet usage and comparisons with other combat systems;
- Technical results expressed in terms of operational impact/risk; and
- Operational perspective provided by active duty Navy Joint Interface Control Officers.

Analysis of System/Platform Interoperability and/or System Integration data allows for identification of system issues across various ship classes, baselines, and system variants, as seen in Figure 11. Interoperability issues resulting from a typical analysis are summarized with recommendations for mitigation. Resolution of these types of issues will require collaboration between multiple program offices, contractors, and other government agencies.

By identifying, solving, or supporting the resolution of interoperability/integration problems and issues, NSWC PHD adds value by bridging the gaps between stovepipe systems, and ensuring systems operate as intended to achieve its mission. As Combat System In-Service Engineering Agent for surface warfare, NSWC PHD helps the surface fleet work together and with other services and allies as an effective instrument of our national policy.



	Air & ASCM Defense	SUW	USW	MIW	EW	STRK	AMB
	PCD	PCD	PCD	PCD	PCD	PCD	PCD
Surveillance Track Reporting	Yellow	Green	Green	Green	Yellow	Yellow	N/A
Identification	Red	Green	Green	Black	N/A	Black	N/A
Mutual Tracking	Yellow	Green	Black	Black	Black	Black	N/A
Positively ID Friendly Forces	Green	Green	Black	Black	Black	Black	N/A
Engagement & Force Status	Yellow	Green	Black	Black	Green	Green	Black
Air Control Support	Red	Red	Red	Black	Black	Yellow	Black

Figure 11. Example of Combat Systems Interoperability Assessment

### Critical Success Elements/Lessons Learned

The critical success elements of the SEAR as a systems engineering tool are identifying the trends overtime and feeding the analysis back to the program office and to the OEM to influence the design. The top issues and cost drivers are identified with proposed solutions and recommendations for improvement. Capturing the impact of the recommendations in follow on SEARs requires coordination and feedback from the program office, as well as more detailed technical discussions with the OEM. When all of this is tied together, the discussion on effectiveness and affordability become powerful drivers for improvements with in-service systems, as well as future designs. Four specific examples resulting from the systems engineering involved in SEAR include the following:

- The identification of transmitters as a reliability driver for a system significantly reduced TOC and workload.
- The SEAR analysis for another system led to the justification of specific tasking shortfalls being identified and funded.
- The identification of Surface Warfare (SUW) suitability issues led to a collaborative SUW white paper provided to the PEO.
- The focus on interoperability led to follow on white papers and concepts being promoted across PEOs and NAVSEA with some already being funded.

These examples show that the lessons learned from the SEAR process are folded back into the acquisition and technical communities. The results of SEAR help address many of senior leadership's goals, such as achieving acquisition excellence, reducing TOC, improving quality, building the future force, maintaining our warfighting readiness, getting the requirements right, and making every dollar count.



### ***Identified Transmitters as a Reliability Driver for a System***

Mean Time Between Failure (MTBF) and Mean Logistics Delay Time (MLDT) were consistently the most significant drivers for low  $A_0$ . Deeper analysis at the subsystem levels showed that the transmitter was also one of the most costly items. Thus, it was frequently not on board when they failed, resulting in long logistics delays, in addition to the low MTBF.

The reliability data, together with the influence of the Fleet's Troubled Systems Program, were used to justify the upgrade to a new transmitter with solid state technology, as well as to upgrade the entire system to a more open architecture. The Solid State Transmitter ORDALT was projected to reduce the cost of ownership by 60% with a savings of \$83,000/ship/year. With concurrent implementation of this ORDALT, the annual Planned Maintenance System (PMS) workload is projected to be reduced by 68% to 78% depending on ship class. The corresponding annual maintenance cost will be reduced by 59% and 77% for these ship classes, respectively. The failure rate of the solid state transmitter was reduced by 94%, thus dramatically increasing the reliability.

### ***The SEAR Analysis for Another System Led to the Justification of Specific Tasking Shortfalls Being Identified and Funded***

During the late nineties, allowed onboard spares for one system were reduced by 50%, which greatly increased Mean Logistics Delays. In addition, the ISEA budget was reduced from approximately \$4 million per annum to less than \$1 million per annum. By working with the Program Manager and the Fleet, NSWV PHD drafted a stop-work message for the PM to disseminate. In the meantime, the Fleet was able to convince OPNAV to restore the budget to previous year's level, given the alternative of no future ISEA support.

### ***Identified SUW Deficiencies During $P_c$ Assessment***

During the  $P_c$  assessment of a recent SEAR, the analysis identified concerns with ships' forces not adhering to technical guidance provided to ensure that circuit card assemblies (CCAs) are configured to maintain Combat System Computer Program Certification status.

As indicated in Figure 12, all of the ships surveyed do not meet the configuration requirements that are needed in order to maintain Combat Systems Computer Program certification status. Most of these ships are in a de-certified status until CCAs are configured in accordance with technical guidance. This finding is influencing the design of future combat systems by reducing the number of configurable items. New technical documentation is being developed to help with troubleshooting efforts from a system of systems perspective. Current technical documentation does not provide detailed guidance to troubleshoot complex system issues. This is leading to improving the training curriculum to re-reinforce the importance of maintaining configuration control, adherence to technical guidance and system level troubleshooting techniques.



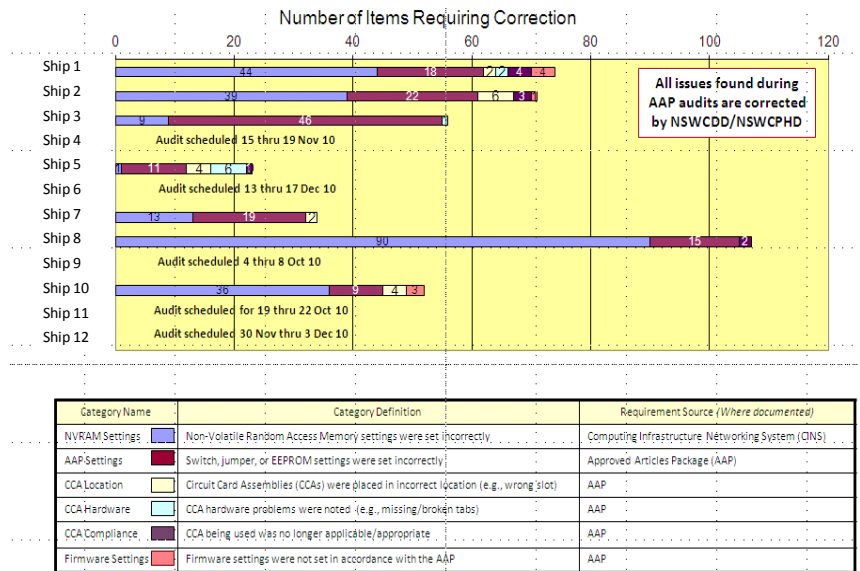

**Figure 12. SEAR P<sub>c</sub> Assessment—Configuration Management of Circuit Card Assemblies (CCAs)**

As part of the SEAR process, a combat system is currently assessed in two primary warfare areas: Air Defense and Surface Warfare. The SEAR SUW P<sub>c</sub> assessment provided an insight into areas that required more attention in order to improve our effectiveness, P<sub>c</sub>. Recent at-sea testing results provided details into how our combat system elements are integrated in a system of systems architecture. The at-sea integration of the various systems, computer programs, and shipboard personnel provides the perfect venue for identifying and better assessing the capabilities and limitations of a combat system in support of all mission areas. The SEAR assessment provided visibility into some of the challenges that the technical community need to address in the following areas:

- Improve situational awareness. These include sensor improvements as well as better information distribution throughout the ship.
- Improve system effectiveness through improved sensor capability (e.g., detection range, accuracy, data rate exchange).
- Improve operator proficiency through training and other means.
- Improve weapons effectiveness primarily by the introduction of a new weapon or SUW mission for an existing weapon.

### **Identified Interoperability Issues and Recommendations**

The focus on interoperability led to follow on white papers and concepts being promoted across PEOs and NAVSEA. Highlights of this effort include the following:

- Need for testing early in the acquisition process and with appropriate resources during at-sea test events.
- Interoperability requirements need to be addressed at the element level, combat system and continue to the system of systems level.
- Need for conduct of a robust interoperability testing early during system integration and evaluation phases. At-sea interoperability test events are conducted in a single ship environment. Interoperability issues are not found

until a new baseline goes into a multi-ship environment, sometimes after deployment.

- Need to improve technical documentation for the operators, provide feedback to the training community, and improve communication among agencies.
- Need for creation of a set of standards (Interoperability metrics) and practices on testing, training, and evaluation to take the ambiguity out of the results. Also, establishing a community infrastructure for interoperability can help resolve a great deal of the conflicts that are present today.
- Increase the emphasis on interoperability during Combat System Computer Program certification. Historically, for emerging Aegis baselines, interoperability has not played a role in Combat System Computer Program Certification. There is a need to place more emphasis on interoperability testing and issues resolution.

### **Future State Goals (Technical and Programmatic)**

The future state is envisioned to have all elements, equipments, and systems of the entire combat system analyzed individually, as well as being rolled up into a higher platform level review. The rigor of a systems engineering approach used in the SEAR process should be adopted across ISEAs. A consistent formalized process will enable the technical community to provide rapid and direct feedback into the acquisition lifecycle. The goal would be to use the analysis and inputs from the In-Service community in the acquisition and design decisions of the program office, other engineering agents, and the OEM. This would allow the government–industry team to affect changes on current systems and define better requirements for designing future systems.

Issues identified through the SEAR process can support program office investments to improve their system readiness. The value of this process has not been widely advertised outside of NSWC PHD. Once mature, the SEAR process can provide metrics that may indicate areas that ships should investigate prior to major inspections, exercises, and deployments. Program managers may benefit from metrics that highlight high cost drivers, maintenance/manning/training issues, diminishing manufacturing sources, reliability/maintainability/availability concerns, and open safety issues.

Another goal is to introduce a Mission-based SEAR that would show the impacts of systems performance in particular mission areas, given the various readiness decisions affecting funding levels and capability upgrades. A phased approach would be utilized, starting with AD and SUW mission areas on a single ship, followed by the addition of Undersea Warfare and Strike. All mission areas on multiple ships would lead in to the mission focus based on Operational and Tactical Situations. This would require more extensive data from Materiel Readiness Database, a new Casualty Reporting database, and the Operational and Tactical Situations block diagram to support analysis.

### ***Increasing Scope to Include Other Warfare Centers/SYSCOMs Who Support ISEA Work and Fleet Sustainment***

The assessments used to produce the data for a SEAR are being conducted at different levels including equipment and system. The challenge is to take the individual equipments, elements, and systems into a holistic platform level SEAR. This is partly due to the differences in analysis methodology used by different ISEAs. The difficulty comes from analyzing and understanding the complexities of stacking or additive effects when rolling up



the data. The main thrust of these reviews is to look at the trends and issues vice the individual metrics.

Even though NSWC PHD is the ISEA for many of the combat systems, other ISEAs need to provide inputs for their systems in order to assess effectiveness of a platform or strike group. For example, C4I systems need to be assessed for impacts to interoperability within a platform, as well as with other platforms within a strike group. Electronic Warfare systems need to be assessed as part of the detect control, and engage missions within a platform. Once the SEAR process is stabilized and tools are available to facilitate data collection, discussions will be initiated with other ISEAs regarding the SEAR process and their possible participation in the assessments. This would allow a better understanding of the element and system level, as well as a more comprehensive look at the system of systems and platform level. This would be extremely useful across multiple program offices and industry partners.

### ***Use of a Database Collaboration Tool***

There are many authoritative databases which address similar issues from different perspectives. A collaboration tool would compare data from various sources to validate ground truth or to investigate specific issues further.

Data collection and sorting has been and still is the most time consuming and laborious part of the SEAR process. Analysis is the critical element of SEAR, which oftentimes is cut short depending on the amount of data collected and sorted. The data collaboration tool would have the data available in the correct format, so that the analysis can be conducted when required—not after the time it takes to collect data.

### ***Information Assurance Assessment***

Navy Cyber Defense Operations Command Computer Tasking Order 06-02 (DTG 062305Z MAR 06) requires all afloat platforms to conduct monthly Information Assurance Vulnerability (IAV) scans. IA needs to be part of the SEAR process and will be added to the list of SEAR metrics.

The ISEA needs to ensure our systems have the capabilities to Protect, Detect, and React to internal and external attacks through the application of security services such as the following: Availability, Integrity, Authentication, Confidentiality, and Non-Repudiation. We need the assurance that information is not disclosed to unauthorized persons, processes, or devices, support cross domain solutions, multiple levels of protection for voice/data traffic and provide cryptographic solutions interoperability between allied/coalition partners and the United States. In addition, attacks are expected to occur, and the detection tools and procedures that will allow the capability to react to and recover, reconstruct, and examine the sequence of events and/or changes in an event need to be in place.

### ***Predictive and Proactive ISE Support***

Currently, the ISEA plans to ensure systems are available when needed. As an example, high failure rate critical parts are spared onboard ships to minimize down times. The spares loadout and approved parts list are developed using various sparing models. This does not prevent failures from occurring—it just minimizes down time. The next step would be for the ISEA to predict when a potential failure of a critical part on a ship will occur and recommend that replacing the part will prevent a system casualty while underway. By knowing when critical parts are replaced, together with the part's MTBF, we can develop the



ship's mission profile and determine if the part has a high probability of failing during a particular mission. A collaboration tool would be required to sort the large amounts of data required to predict potential failures that may impact a ship's mission. As with most of the information from the SEAR, this is critical to share with the program office and industry, so that contracts can be put in place and the appropriate infrastructure can be established, allowing the Navy to buy the right parts at the right time with minimal delay time.

***Redesign the SEAR Process so That It Incorporates Elements of the Capabilities Based Assessment Methodology in Order to Provide Relevant Recommendations to Our Program Managers***

Definition: The Capabilities Based Assessment (CBA) is the Joint Capabilities Integration and Development System analysis process. It answers several key questions for the validation authority prior to their approval: define the mission; identify capabilities required; determine the attributes/standards of the capabilities; identify gaps; assess operational risk associated with the gaps; prioritize the gaps; identify and assess potential non-materiel solutions; and provide recommendations for addressing the gaps (CJCS, 2009).

The SEAR focus needs to address “what it takes to win” for a warfare area, major combat operation, or a specific mission thread, and not transformation for transformation's sake. The SEAR recommendations need to identify the optimal mix of assets (Sensors, Weapons, C2, Networks, Platforms, Warriors) and the functional, performance, and integration requirements and candidate solutions to support warfighter operational requirements. The SEAR recommendations need to support acquisition decision-making by providing traceability back to warfighter requirements. It must also assess the impact of programmatic trades, system failures, and engineering decisions on warfighter capability, including management of materiel and non-materiel solutions.

By using the CBA methodology, the SEAR will provide the program manager with recommendations with clear impacts to a warfare area requirement, major combat operation requirement, or specific mission thread requirement. The SEAR recommendation should identify interoperability and other technical risk areas in a systems architecture and the impact of potential issues on the operational mission.

**Warfare Center Future Way Ahead Recommendations**

The way ahead for the SEAR should be to adopt more robust systems engineering processes across engineering agents to better assess the systems they support not only at the equipment or system level but at a more comprehensive platform level. The SEAR process is the backbone and foundation of the systems engineering process at NSWC PHD. The leadership at PEO IWS has embraced this systems engineering approach and recognizes the usefulness and value that it adds. Plans are in process to expand this process across the ISEAs to allow for all elements and systems to be rolled up into the platform level SEARs, which would provide more insight into the whole integrated combat system. This approach will allow the warfare centers to fully data mine and integrate the information that is already collected. Ultimately, this would enable a comprehensive and fully integrated view of Fleet performance. It would provide the necessary information to the PEO to understand the state of the Fleet, to identify affordability and TOC initiatives, as well as to support the Navy's budgetary process by raising critical Fleet issues. Industry can also



use this information to better understand the requirements, improve their current products, and incorporate them into future system designs more effectively and efficiently.

The objective of the way forward in applying this systems engineering process is to provide detailed feedback from the Fleet and In-Service community to the program office and industrial base, which provides insight and helps drive well-informed decisions. It should provide valuable inputs to the future performance requirements and design assumptions, such as manning levels, crew training, logistics, and maintenance issues. This process must maximize the use of existing authoritative data from across the community.

This paper supports the recommendations that the SEAR process, as a fundamental systems engineering tool, should be utilized by ISEAs for systems under their cognizance. As the Combat Systems ISEA, NSWC PHD will then be able to roll up the individual equipment, elements, and systems into a more inclusive platform level assessment. The products of the SEAR should be provided to the PEOs to allow them to make more informed acquisition decisions that will impact the future design and upgrades. The information must also be shared among the other Engineering Agents and the OEM, so that the information from the in-service perspective can affect change early in the design process and acquisition lifecycle.

## References

- Brower, K. F. (2010, December). *Mission based SEAR* [Presentation].
- Cipriano, J. R. (n.d.). *The availability of a capability*.
- CJCS. (2009, March 1). *Joint capabilities integration and development system* (CJCS Instruction 3170.01G). Washington, DC: Author.
- Naval Surface Warfare Center Port Hueneme Division (NSWC PHD). (2001, June). *PHD NSWC safety, effectiveness, and affordability review guide*. Port Hueneme, CA: Author.
- SECNAV. (2008, December 22). *Acquisition and capabilities guidebook* (SECNAV M-5000.2). Washington, DC: Author.
- Wakatsuki, G. (2007, July). *Safety, effectiveness, and affordability review (SEAR)* [Presentation].

